

Clearwall™ Curtain Wall

4-Sided Toggle Glazed (TG) Curtain Wall System

Clearly Different.
Clearly Innovative.

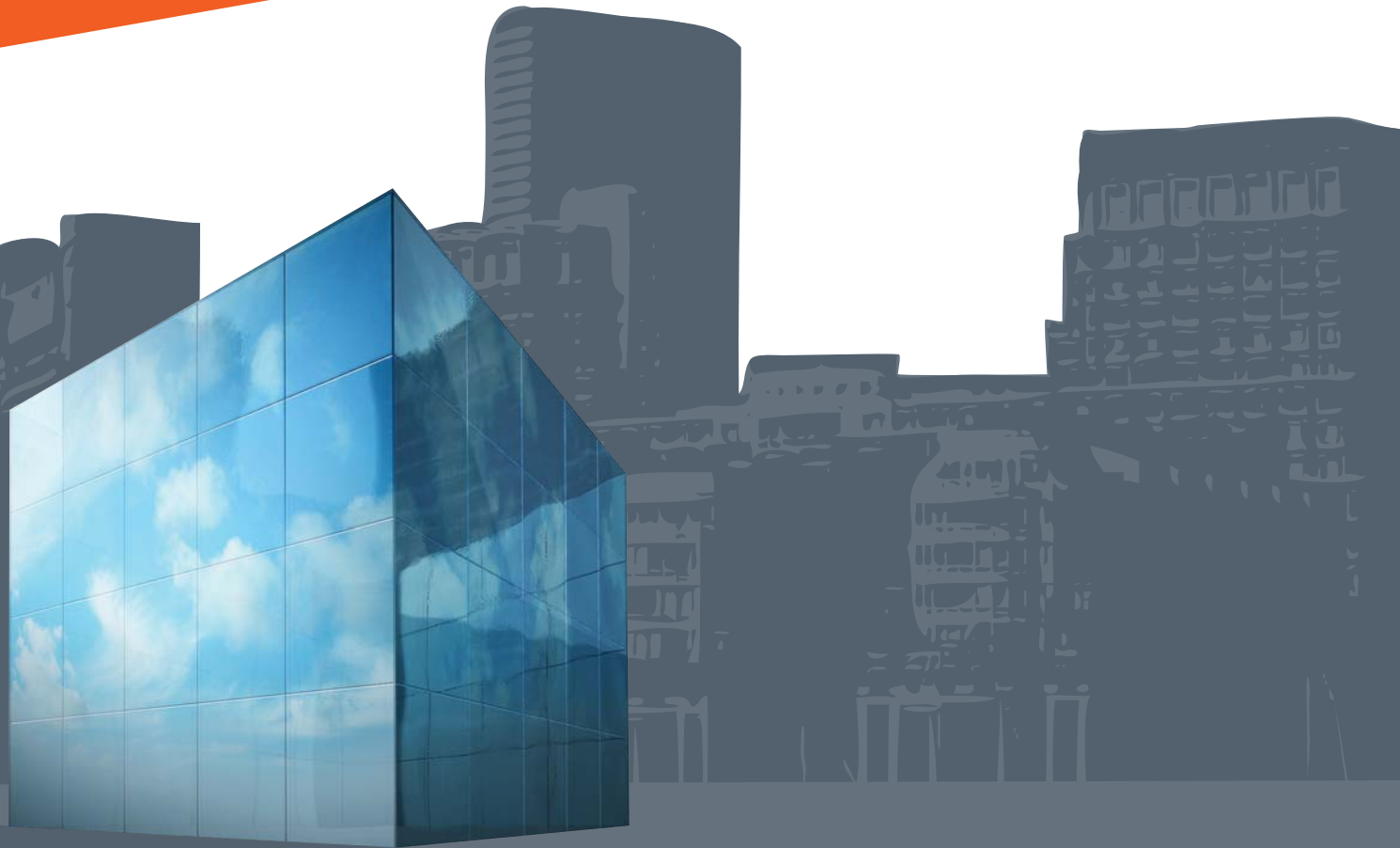

Today, a growing number of architects are designing buildings with sleek, uninterrupted all-glass façades. Clearwall™ curtain wall, an innovative 4-sided Toggle Glazed (TG) system*, delivers this highly desired aesthetic for low-rise applications. Clearwall™ curtain wall strikes a balance of form and function through its groundbreaking toggle design, which reduces installation labor, simplifies on-site logistics and enhances safety while providing superior aesthetics. Featuring inspired design, tight construction and brilliant results, Clearwall™ curtain wall is clearly different and clearly innovative.

* Multiple patents pending

Aesthetics

Now architects have a clear option when they want an admired monolithic look for low-rise applications. Kawneer's Clearwall™ curtain wall, an outside glazed system, achieves the desired appearance of a 4-sided structural silicone glazed (SSG) system using a unique toggle assembly that directly captures glass. And because it was developed specifically with low-rise commercial and institutional building applications in mind, Clearwall™ curtain wall provides the same aesthetic as 4-sided SSG, point-supported glass or unitized curtain wall systems at a fraction of the cost. The innovative curtain wall system also features various mullion depths for increased design flexibility based on project requirements.

Fabrication and Installation

Clearwall™ curtain wall's greatest efficiency is achieved by eliminating the field application of structural silicone and its associated cure times. During glazing, the toggle assemblies mechanically capture the inboard lite of adjacent recessed spacer insulating glass units. Other glazing options allow toggles to capture a metal interface attached to a regular insulating glass unit. Additionally, straight cuts without notching simplify fabrication, while screw spline construction allows frames to be pre-assembled in the shop and shipped ready to glaze to the job site, reducing on-site handling and labor time. Shear block construction is also available with deeper mullions and optional steel reinforcement for higher free span applications.

Screw Spline System

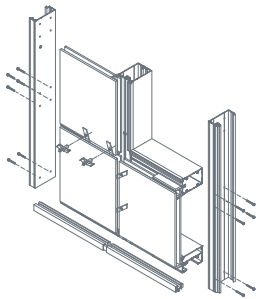

Shear Block System

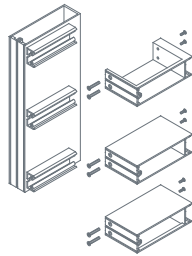

Clearwall™ curtain wall offers three Toggle Glazing (TG) options (Screw Spline System shown)

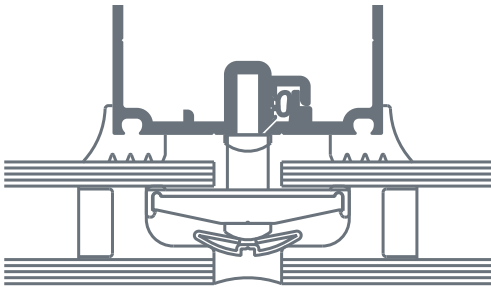

1. Clearwall™ SS (Screw Spline) or SB (Shear Block): In this standard glazing option, toggles capture the inboard lite of 1-1/8" recessed spacer insulating glass units†. This combination completely eliminates the use of any structural silicone, thereby saving costly application and cure times.

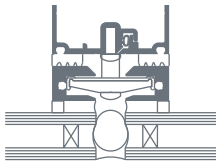

2. Clearwall™ SSI (Screw Spline Interface) or SBI (Shear Block Interface): In this glazing option, toggles capture a metal interface, which is shop-applied to standard 1" insulating glass with structural silicone.

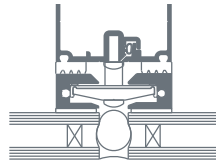

3. Clearwall™ SSIT (Screw Spline Interface Tape) or SBIT (Shear Block Interface Tape): In this glazing option, toggles capture a metal interface, which is shop-applied to standard 1" insulating glass with 3M™ VHB™ Structural Glazing Tape (SGT)††.

† Recessed spacer insulating glass units by Viracon

†† 3M and VHB are trademarks of 3M Company

Performance

For enhanced energy efficiency, the system accommodates 1-1/8" and 1" insulating or laminated glass, which provides increased thermal performance and enhances STC and OITC (sound resistance) performance. Clearwall™ curtain wall has been tested in accordance with North American performance standards, including seismic, thermal cycling and dynamic water.

CLEARWALL™ CURTAIN WALL - PERFORMANCE TEST STANDARDS

Air Infiltration	ASTM E 283
Water – static	ASTM E 331
Water – dynamic	AAMA 501.1 AAMA 520
Structural – uniform wind load	ASTM E 330 & TAS 202
Thermal Cycling	AAMA 501.5
Thermal Transmittance – U factor	AAMA 1503 AAMA 507 NFRC 100
Condensation Resistance (CRF, I, CR)	AAMA 1503 CSA 440 NFRC 500
Overall Solar Heat Gain Coefficient (SHGC & VT)	NFRC 200 AAMA 507
Sound Transmission Class (STC, OITC)	ASTM E 90 ASTM E 1425
Seismic	AAMA 501.4

For the Finishing Touch

Architectural Class I anodized aluminum finishes are available in clear and Permanodic® color choices.

Painted finishes, including fluoropolymer, that meet AAMA 2605 are offered in many standard choices and an unlimited number of specially designed colors.

Solvent-free powder coatings add the "green" element with high performance, durability and scratch resistance that meet the standards of AAMA 2604.

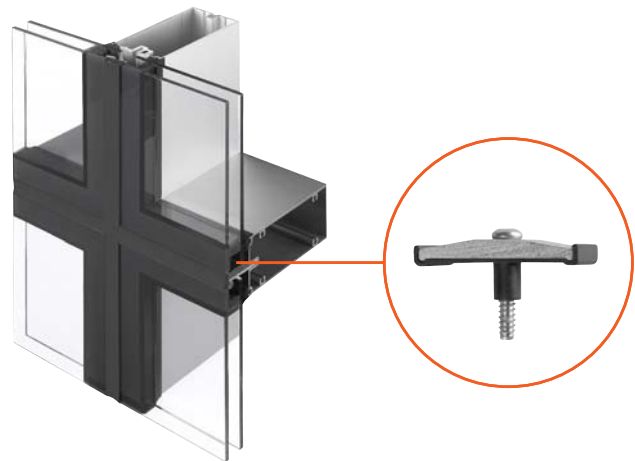

Exterior view of Clearwall™ SS curtain wall with toggle

Kawneer Company, Inc.
Technology Park / Atlanta
555 Guthridge Court
Norcross, GA 30092

kawneer.com
kawneergreen.com
770 . 449 . 5555

KAWNEER
AN ALCOA COMPANY

